

DEUTZ TCD 9.0/12.0/13.5

For mobile machinery ■ 304 - 454 kW / 413 - 617 hp at 1700-2100 min⁻¹/rpm ■ EU V, US T4, CN 4, EU III A

- Water-cooled 4- and 6-cylinder inline engines with turbo-charging and with charge air cooling.
- Engine and exhaust aftertreatment (EAT) are optimised for highest total system efficiency and thus ensure lowest consumption and total operating cost.
- Consistent installation and connection dimensions of the engine facilitate the changeover of existing installations to the next stage of the emission laws. The size and design of the engines will remain identical in the change to US Tier 4 and EU Stage V due to a protected technology. No changes to the customer's device. A variant without EAT is available as an option for less regulated markets.
- The powerful Common Rail injection system and the electronic engine control with intelligent link to the drive management ensure optimum engine performance at low fuel consumption.
- In terms of aftertreatment, for higher regulated markets, the engines are expected to have no EGR and meet Stage V emissions regulations with a diesel oxidation catalyst (DOC) + SCR with a diesel particulate filter (DPF) and SCR packaged in a single unit. For U.S. Tier 4, and CN 4, the engines will have SCR only. For lower regulated markets the engines will meet the requirements with just EGR and no aftertreatment.
- Long oil change intervals and easy changing of the engine fluids reduce the running cost and increase the availability of the machinery.
- Best cold starting performance even under extreme conditions.
- The extremely compact engine design and customer friendly accessories reduce the installation cost and increase the number of applications.



TECHNICAL DATA

Engine type		TCD 9.0 L4	TCD 12.0 L6	TCD 13.5 L6
No. of cylinders		4	6	6
Bore/stroke	mm in	135/157 5.3/6.2	130/150 5.1/5.9	135/157 5.3/6.2
Displacement	l cu in	9.0 550	12.0 732	13.5 824
Max. nominal speed	min ⁻¹ rpm	2100	2100	2100

Engine type		TCD 9.0 L4	TCD 12.0 L6	TCD 13.5 L6
Power output as per ISO 9249 ¹⁾	kW hp	304 413	404 734	454 617
at speed	min ⁻¹ rpm	1700 - 2100	1700 - 2100	1700 - 2100
Max. torque	Nm lb/ft	1710 1261	2505 1848	2757 2033
at speed	min ⁻¹ rpm	1200 - 1600	1200 - 1400	1100 - 1500
Minimum idling speed	min ⁻¹ rpm	800	600	600
Weight as per DIN 70020 Part 7A ²⁾	kg lb	808 1781	983 2167	990 2183

1) Power data without deduction of fan power

2) Without starter/alternator, cooler and fluids but with flywheel and flywheel housing

CHARACTERISTIC CURVES

TCD 9.0 L4 TCD 12.0/13.5 L6

Power

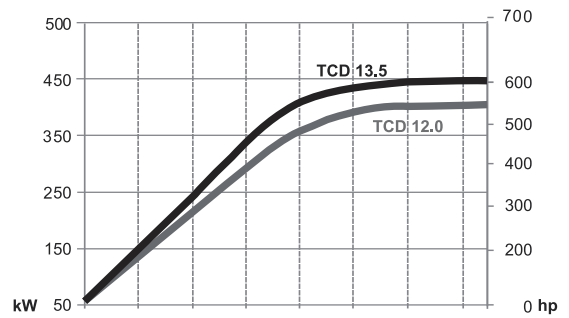
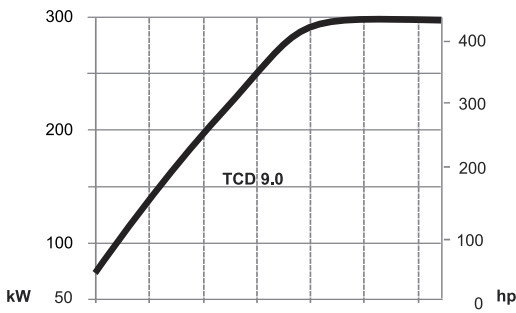

Torque

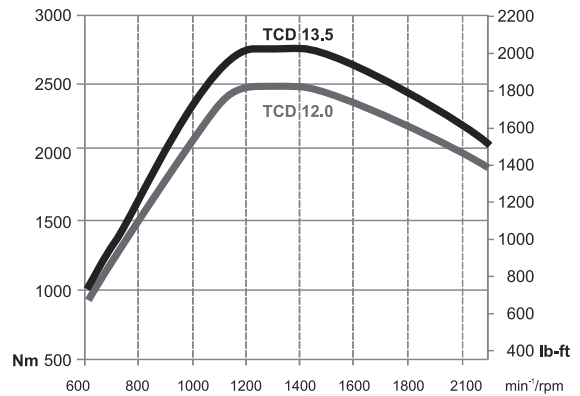
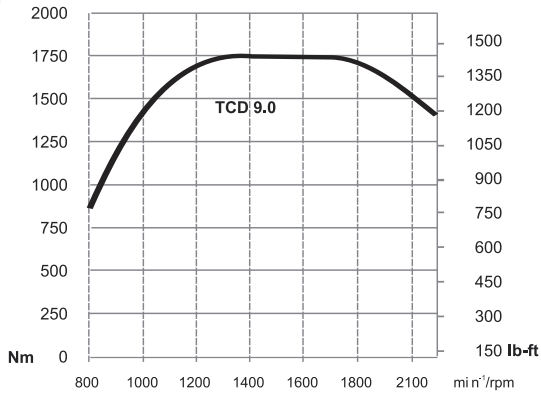

DIMENSIONS

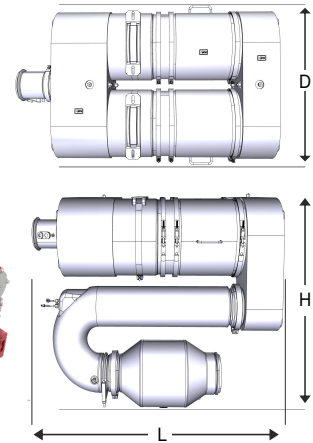
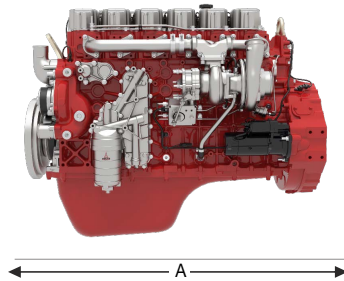
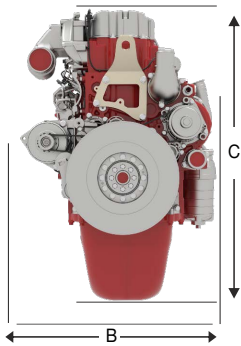

EAT

Engine Type		A	B	C	D	L	H	DOC	SCR	DPF
TCD 9.0 L4	mm in	1057 41.6	827 32.6	1140 44.9	362 14.3 (362 14.3*)	1298 51.1 (1110 43.7*)	1193 46.8 (1058 41.7*)	■	■	■
TCD 12.0 L6	mm in	1378 54.3	852 33.5	1161 45.7	852 33.5 (361 14.2*)	1312 51.7 (1379 54.3*)	917 36.1 (1058 41.7*)	■	■	■
TCD 13.5 L6	mm in	1378 54.3	852 33.5	1161 45.7	852 33.5 (361 14.2*)	1312 51.7 (1379 54.3*)	917 36.1 (1058 41.7*)	■	■	■

- Standard for EU Stage V
- Standard for US Tier 4

For EU Step IV / EPA Tier 4 and for EU Stage V.
All connection variants are available either in 0° or 90° positions for inlet and outlet flanges.

Note: The engine dimensions and weights vary depending on the scope of delivery.

For more information please contact the DEUTZ AG or the responsible sales partner.

DEUTZ AG
Ottostraße 1
51149 Cologne, Germany
Phone: +49 (0) 221 822-0
Telefax: +49 (0) 221 822-3525
E-Mail: info@deutz.com
www.facebook.com/deutzofficial
www.deutz.com

The engine company.